

40 - ESKATT
 847 - KATOWICE
 UL. BOCHENSKIEGO 81

| | | | |
|-----------------------|--|--|---------------|
| PRZEDMIOT OPRACOWANIA | SYSTEMY BALUSTRAD | | |
| NAZWA RYSUNKU | ES-LIGHT-PANEL-4600-200-600 Podświetlany pochwył balustrady | | SKALA: 1:1 |
| AUTOR OPRACOWANIA | PODPIS | DATA 12.03.2010 NR RYS. LIGHT/4600 200/600/1 | |

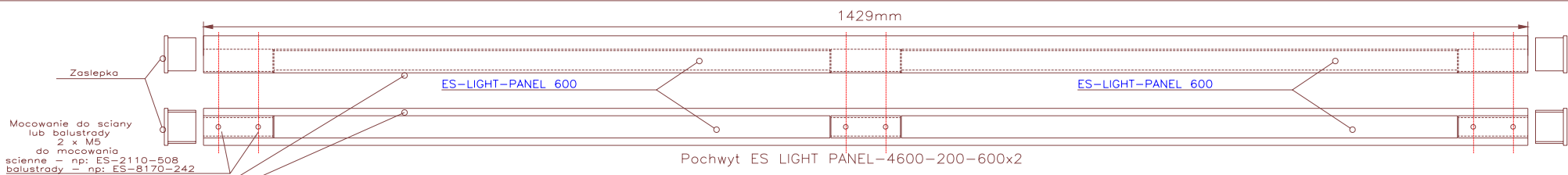

Profil balustrady 40x40

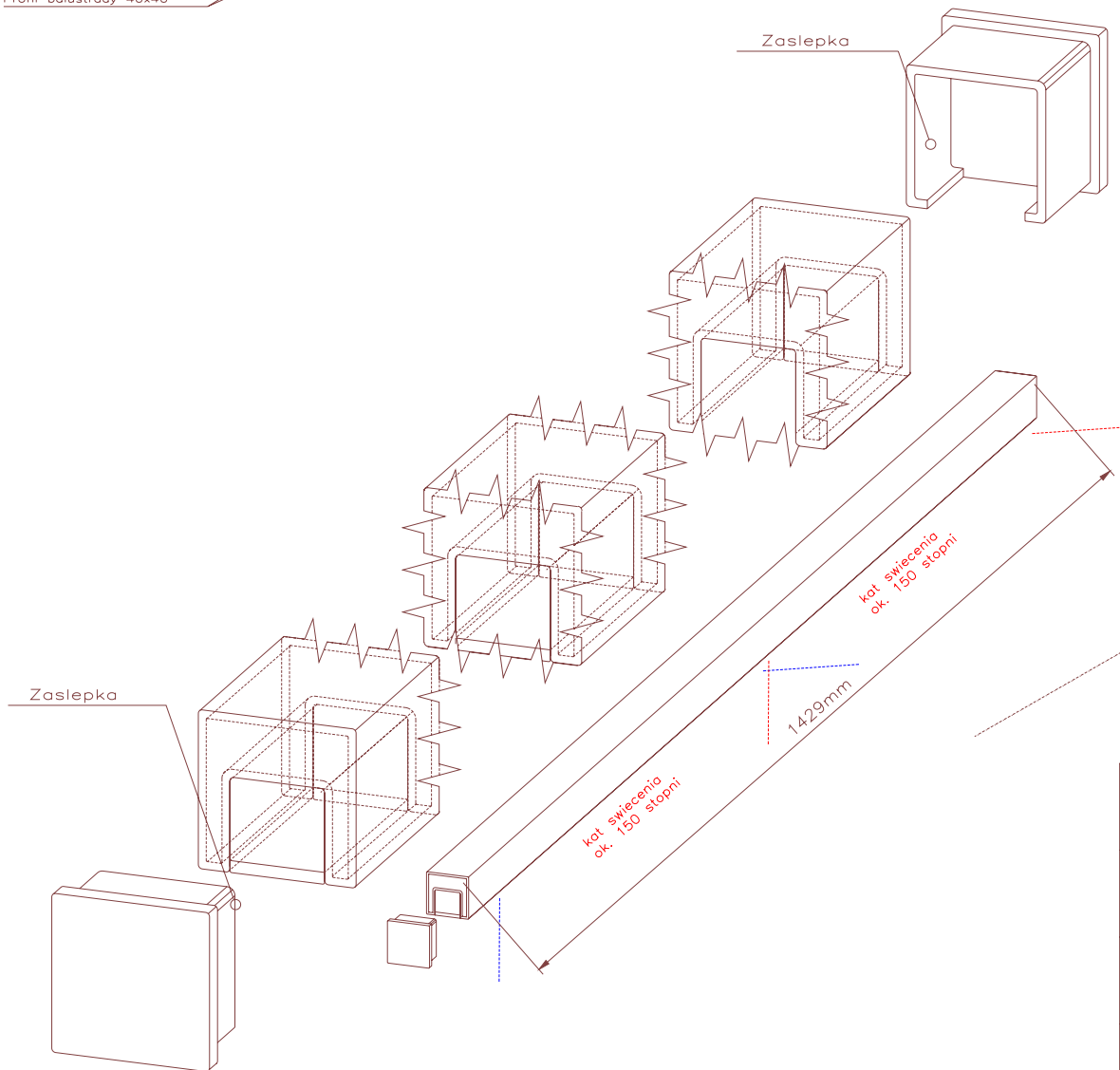
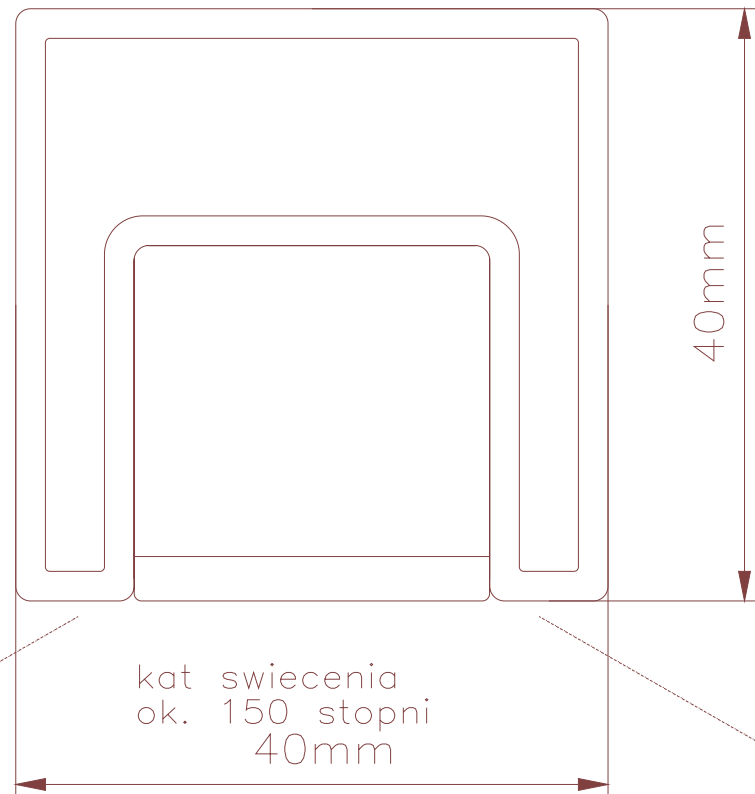
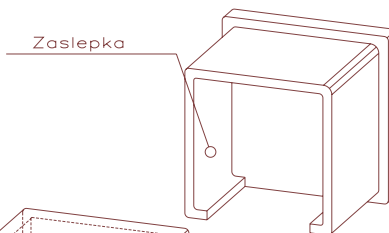

40 - 847 KATOWICE
UL. BOCHENSKIEGO 81

| | | | |
|-----------------------|--|---------|-------------------------|
| PRZEDMIOT OPRACOWANIA | SYSTEMY BALUSTRAD | | |
| NAZWA RYSUNKU | ES-LIGHT-PANEL-4600-200-600x2 Podświetlany pochwył balustrady | SKALA: | 1:1 |
| AUTOR OPRACOWANIA | PODPIS | DATA | 12.03.2010 |
| | | NR RYS. | LIGHT/4600 200/600/2 |

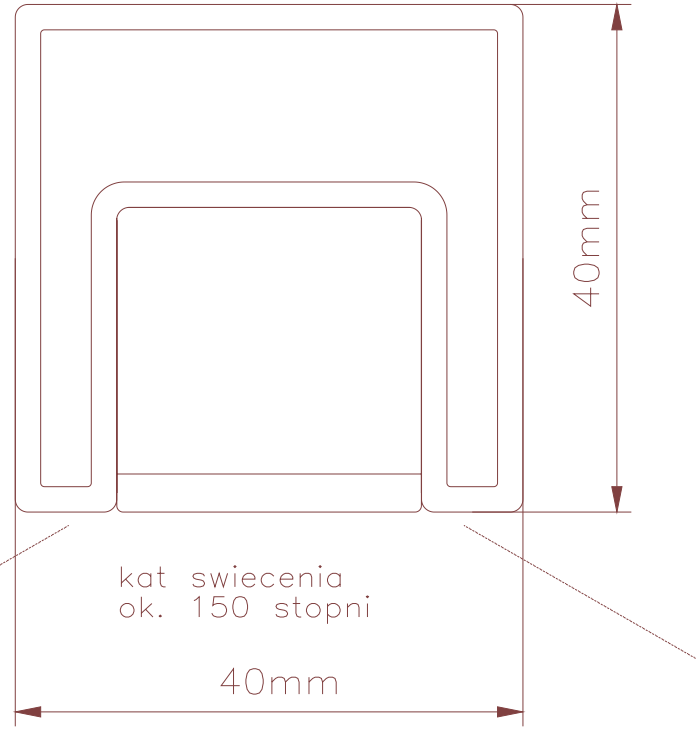
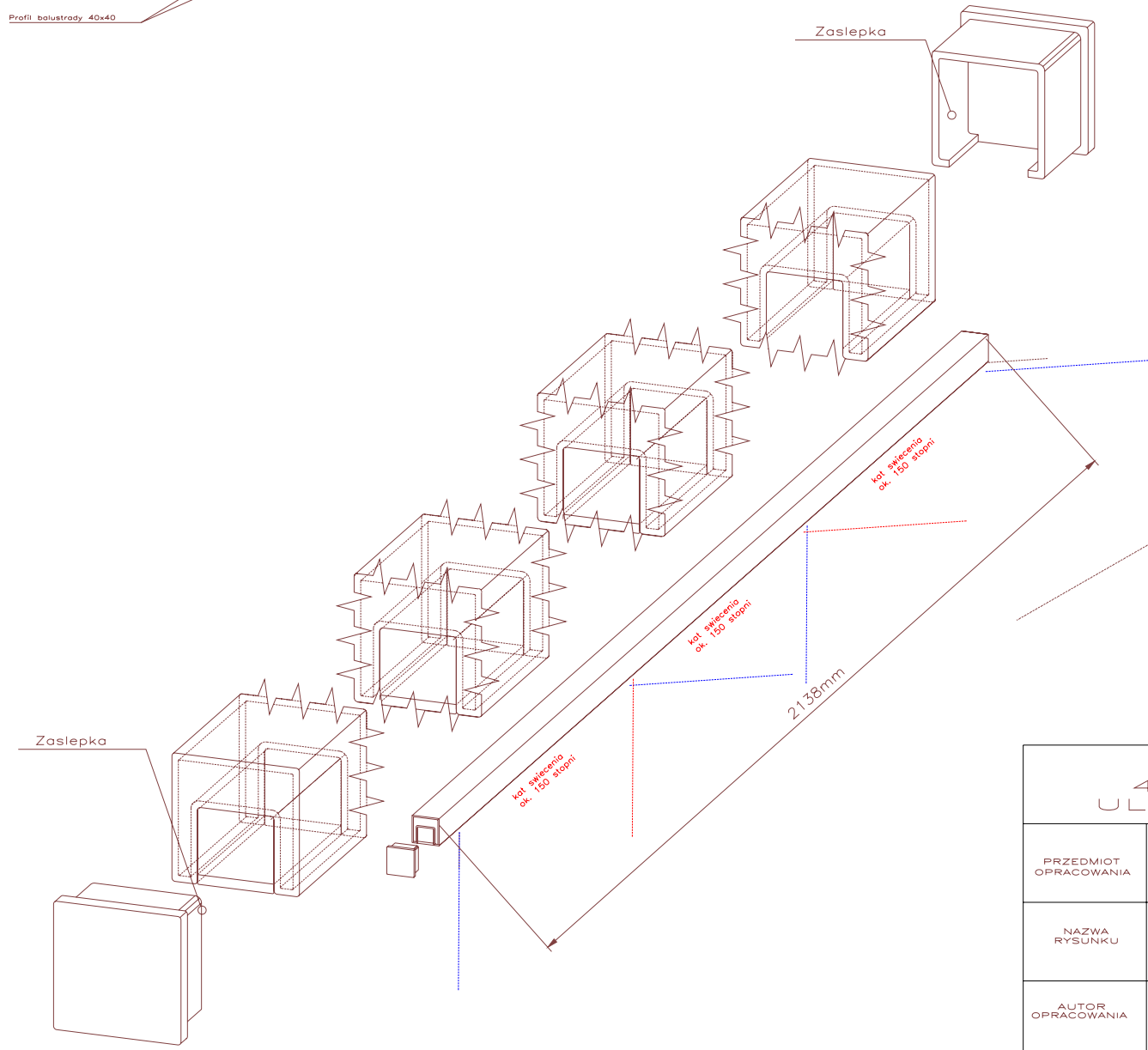
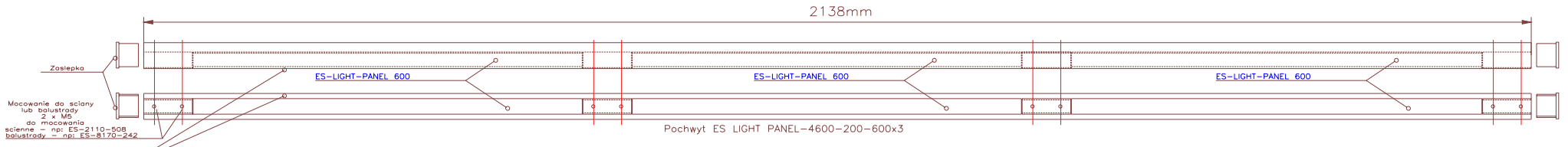

| | | | |
|--|--|---------|-------------------------|
| 40 - ESKATT 847 KATOWICE UL. BOCHENSKIEGO 81 | | | |
| PRZEDMIOT OPRACOWANIA | SYSTEMY BALUSTRAD | | |
| NAZWA RYSUNKU | ES-LIGHT-PANEL-4600-100-600x3 Podświetlany pochwyt balustrady | SKALA: | 1:1 |
| AUTOR OPRACOWANIA | PODPIS | DATA | 12.03.2010 |
| | | NR RYS. | LIGHT/4600 200/600/3 |

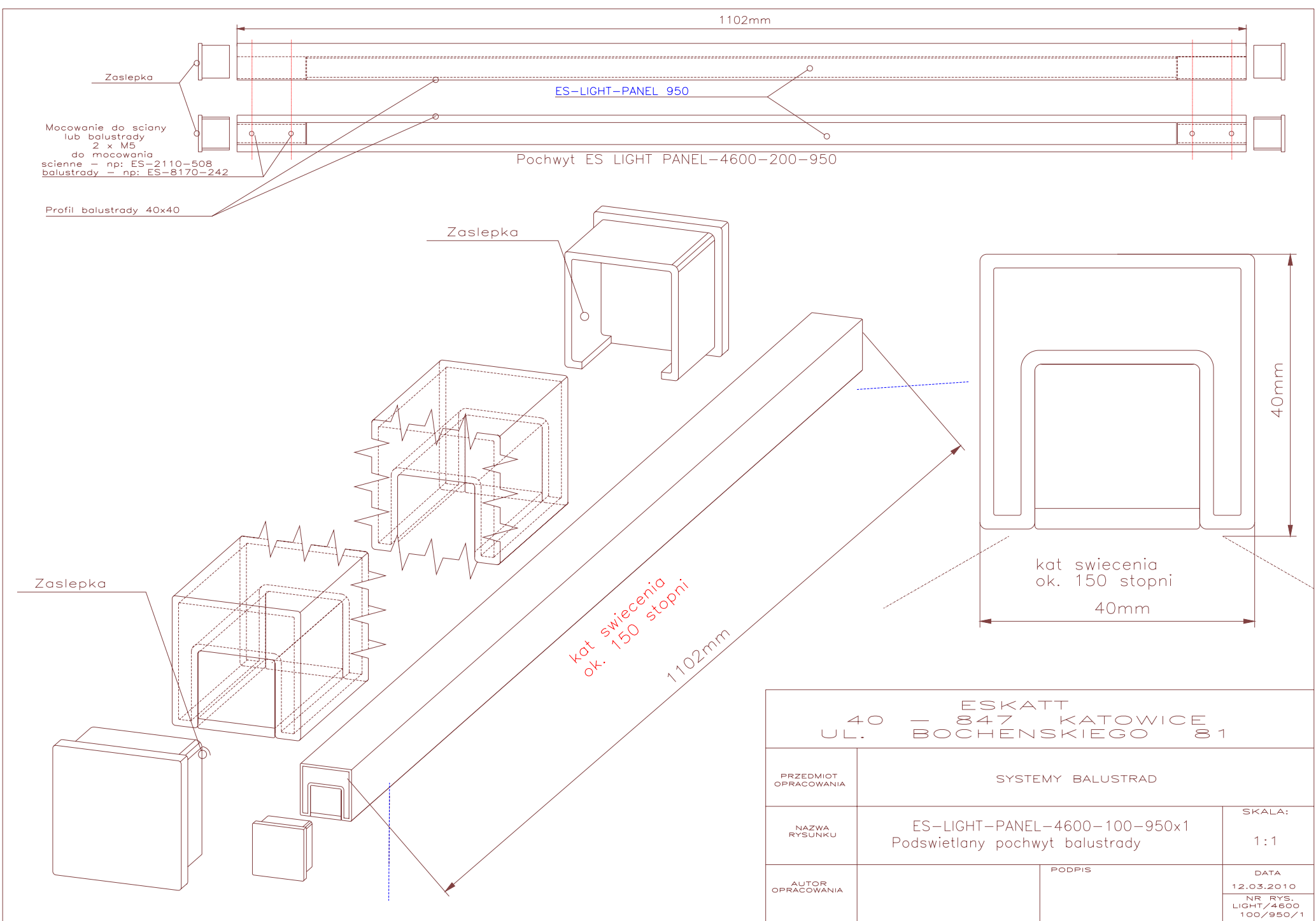

40 - ESKATT
 847 - KATOWICE
 UL. BOCHENSKIEGO 81

| | | | |
|-----------------------|--|---------|-------------------------|
| PRZEDMIOT OPRACOWANIA | SYSTEMY BALUSTRAD | | |
| NAZWA RYSUNKU | ES-LIGHT-PANEL-4600-100-950x1 Podświetlany pochwył balustrady | SKALA: | 1:1 |
| AUTOR OPRACOWANIA | PODPIS | DATA | 12.03.2010 |
| | | NR RYS. | LIGHT/4600 100/950/1 |

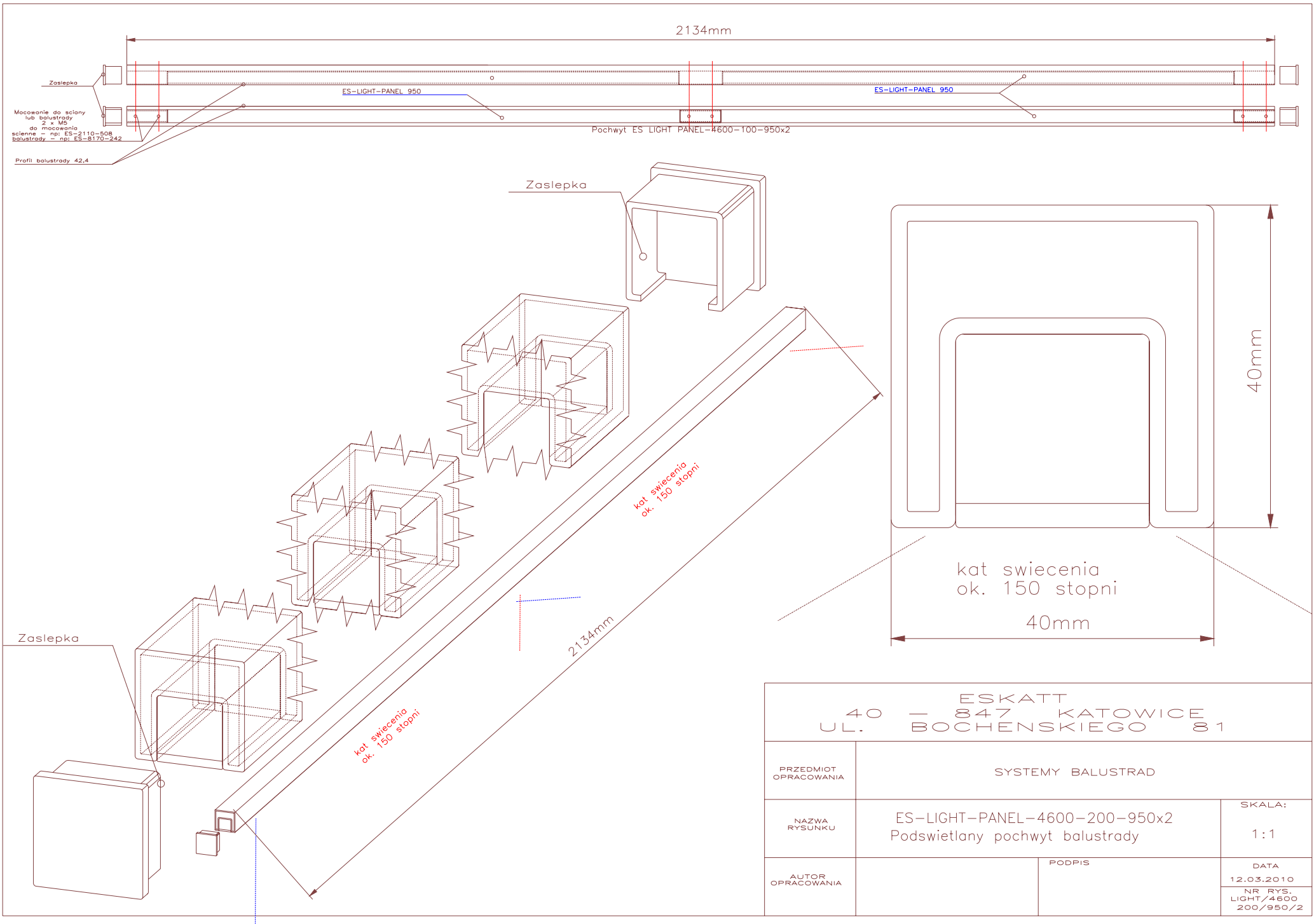

40 - ESKATT
 847 - KATOWICE
 UL. BOCHENSKIEGO 81

| | | | |
|-----------------------|--|---------|-------------------------|
| PRZEDMIOT OPRACOWANIA | SYSTEMY BALUSTRAD | | |
| NAZWA RYSUNKU | ES-LIGHT-PANEL-4600-200-950x2 Podświetlany pochwył balustrady | SKALA: | 1:1 |
| AUTOR OPRACOWANIA | PODPIS | DATA | 12.03.2010 |
| | | NR RYS. | LIGHT/4600 200/950/2 |

3043mm



Montaż do ściany lub balustrady
2 x M6
do montażu do ściany - rozr. ES-110-006
balustrady - rozr. ES-8170-242
Profil epoksydowy 40x40

Zaslepka

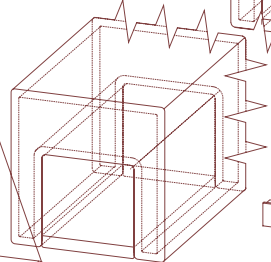
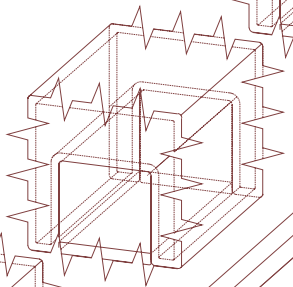
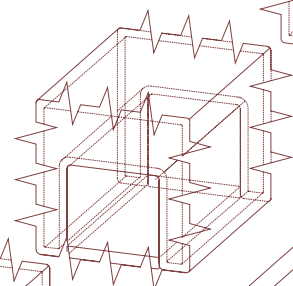
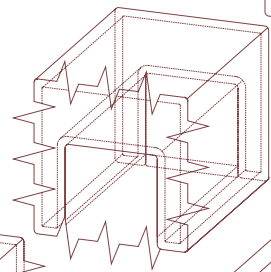
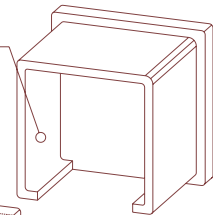

Zaslepka

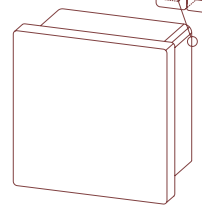

kat. świecenia ok. 150 stopni

kat. świecenia ok. 150 stopni

kat. świecenia ok. 150 stopni

3043mm

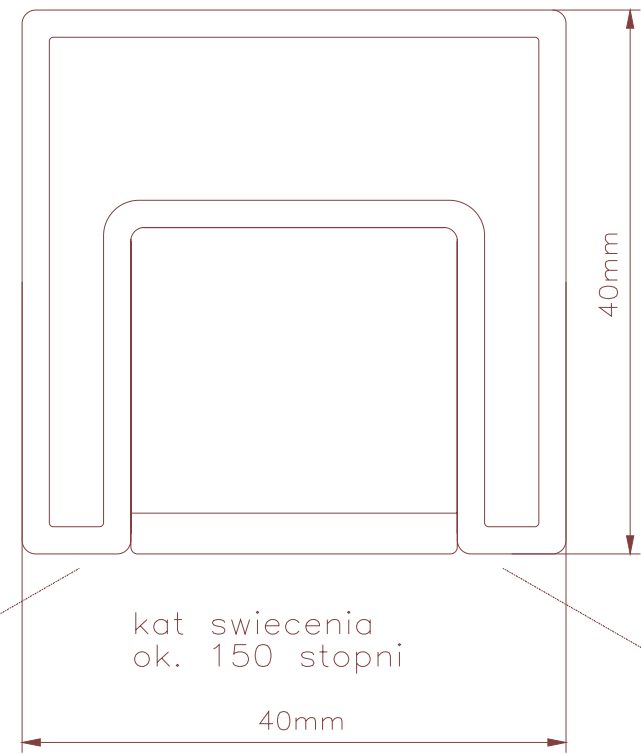

40 - ESKATT
- 847 KATOWICE
UL. BOCHENSKIEGO 81

SYSTEMY BALUSTRAD

| | | |
|----------------------|--|--|
| | SYSTEMY BALUSTRAD | |
| RYSUNKU | ES-LIGHT-PANEL-4600-200-950x3 Podświetlany pochwył balustrady | SKALA: 1:1 |
| AUTOR OPRACOWANIA | PODPIS | DATA 12.03.2010 NR RYS. LIGHT/4600 200/950/3 |